



# LC6108

## Max.2A Li-ion Switching Charger IC

### DESCRIPTION

The LC6108 is a 2A Li-Ion battery switching charger intended for 12V. Low power dissipation, an internal MOSFET and its compact package with minimum external components requirement makes the LC6108 ideal for portable applications. The LC6108 includes complete charge termination circuitry, automatic recharge and a  $\pm 1.5\%$  4.2V/4.35V float voltage.

External sense resistor and Reverse diode is not need. Build-in thermal feedback mechanism regulates the charge current to control the die temperature during high power operation or at elevated ambient temperature.

Battery charge current, charge timeout and end-of-charge indication parameters can program by external components. Additional features include shorted cell detection and overvoltage protection.

The LC6108 is available in DFN3x3-12L package.

### FEATURES

- Very Low Power Dissipation
- 2A Maximum Charge Current
- Standalone Capability with no Requirement of External MOSFET, Sense Resistor or Blocking Diode
- Constant-Current/Constant-Voltage Operation with Thermal Regulation to Maximize Charge Rate Without Risk of Overheating
- Charges Single Cell Li-Ion Batteries Directly from USB Port
- Drainage Charge Current Thermal Regulation Status Outputs for LED or System Interface
- Preset 4.2V/4.35V float Voltage with  $\pm 1.5\%$  Accuracy
- Automatic Recharge
- Available in DFN3x3-12L Package
- RoHS Compliant and 100% Lead (Pb)-Free

### APPLICATIONS

- Cellular Telephones, PDA, MP3 Players
- Charging Docks and Cradles
- Handheld Battery-Powered Devices
- Handheld Computers

### TYPICAL APPLICATION

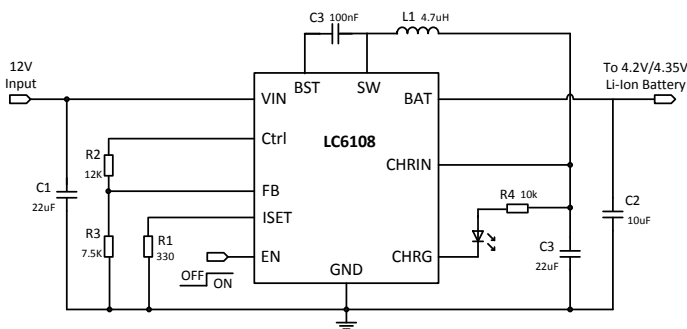

**Note:** Device parameter should be select as typical application

### PIN OUT & MARKING

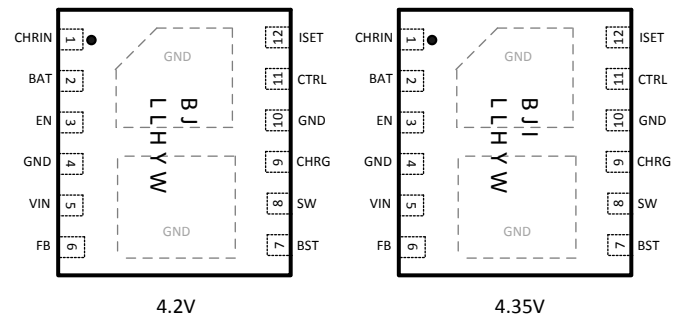

4.2V

DFN3x3-12L

4.35V

BJ: Product Code

LL: LOT NO. H: FAB Code

YW: Date code (Year & Week)

## ORDERING INFORMATION

PART No.	PACKAGE	Tape&Reel
LC6108CKATR42	DFN3x3-12L	3000/Reel
LC6108CKATR435	DFN3x3-12L	3000/Reel

## ABSOLUTE MAXIMUM RATING

Parameter	Value
Max Input Voltage	18V
Max Operating Junction Temperature(Tj)	125°C
Ambient Temperature(Ta)	-40°C – 85°C
Storage Temperature(Ts)	-55°C - 150°C
Lead Temperature & Time	260°C, 10S

**Note:** Exceed these limits to damage to the device. Exposure to absolute maximum rating conditions may affect device reliability.

## RECOMMENDED WORK CONDITIONS

Parameter	Value
Input Voltage Range	Max. 16V
Operating Junction Temperature(Tj)	-40°C – 85°C

## ELECTRICAL CHARACTERISTICS

(V<sub>CH<sub>RIN</sub></sub>=5V, T<sub>A</sub>=25°C)

Symbol	Parameter	Conditions	Min	Typ	Max	Unit
V <sub>IN</sub>	Voltage Range		5		16	V
I <sub>CH<sub>RIN</sub></sub>	Input Supply Current	Charge Mode, R <sub>ISET</sub> = 10k, Standby Mode (Charge Terminated)(Note)		300	2000	uA
		Shutdown Mode (R <sub>ISET</sub> Not Connected)		200	500	
		V <sub>CH<sub>RIN</sub></sub> < V <sub>BAT</sub> , or V <sub>CH<sub>RIN</sub></sub> < V <sub>UV</sub> )		30	50	
V <sub>FLOAT</sub>	Regulated Output (Float) Voltage	0°C ≤ T <sub>A</sub> ≤ 85°C, I <sub>BAT</sub> = 40mA	4.14	4.2	4.26	V
			4.285	4.35	4.415	
I <sub>BAT</sub>	BAT Pin Current	R <sub>ISET</sub> = 1.8k, R <sub>2</sub> =100k, R <sub>3</sub> =75k, Current Mode	450	500	550	mA
		R <sub>ISET</sub> = 0.41k, R <sub>2</sub> =110k, R <sub>3</sub> =75k, Current Mode	1.44	1.6	1.76	A
		R <sub>ISET</sub> = 0.33k, R <sub>2</sub> =120k, R <sub>3</sub> =75k, Current Mode	1.8	2	2.2	A
		Standby Mode, V <sub>BAT</sub> = 4.2V Shutdown Mode (R <sub>ISET</sub> Not Connected) Sleep Mode, V <sub>CH<sub>RIN</sub></sub> = 0V	0	-2.5	-6	uA
		1	5			
I <sub>TRIKL</sub>	Trickle Charge Current	V <sub>BAT</sub> < V <sub>TRIKL</sub> , R <sub>ISET</sub> = 2k	20	45	70	mA
V <sub>TRIKL</sub>	Trickle Charge Threshold Voltage	R <sub>ISET</sub> = 10k, V <sub>BAT</sub> Rising	2.8	2.9	3.0	V
V <sub>TRHYS</sub>	Trickle Charge Hysteresis Voltage	R <sub>ISET</sub> = 10k	60	85	110	mV
V <sub>ISET</sub>	ISET Pin Voltage	R <sub>ISET</sub> = 10k, Current Mode	0.93	1	1.07	V
V <sub>CH<sub>RG</sub></sub>	CHRG Pin Output Low Voltage	I <sub>CH<sub>RG</sub></sub> = 5mA		0.315	0.6	V
ΔV <sub>RECH<sub>RG</sub></sub>	Recharge Battery Threshold Voltage	V <sub>FLOAT</sub> - V <sub>RECH<sub>RG</sub></sub>	100	160	200	mV

**Note :** Supply current includes ISET pin current (approximately 100μA) but does not include any current delivered to the battery through the BAT pin (approximately 100mA).

## PIN DESCRIPTION

PIN #	NAME	DESCRIPTION
1	CHRIN	Power Path Output Voltage.
2	BAT	Battery Charger Output Terminal. Connect a 10 $\mu$ F ceramic chip capacitor between BAT and GND to keep the ripple voltage small.
3	EN	Enable Input Pin. Pulling the EN pin low places the LC6108 into a low power state where the BAT drain current drops to less than 3 $\mu$ A and the supply current is reduced to less than 50 $\mu$ A. For normal operation, pull the pin high.
4、 10	GND	Ground.
5	VIN	Positive Supply Voltage Input. This pin connects to the power devices inside the chip. VIN ranges from 5V to 16V for normal operation. Operation down to the under-voltage lockout threshold is allowed with current limited wall adapters. Decouple with a 22 $\mu$ F or larger surface mounted ceramic capacitor.
6	FB	Battery Feedback Voltage.
7	BST	Bootstrap. A capacitor connected between SW and BST pins is required to form a floating supply across the high-side switch driver.
8	SW	Switch Node Connection. This pin connects to the drains of the internal main and synchronous power MOSFET switches. Connect to external inductor.
9	CHRG	Open-Drain Charge Status Output. When the battery is charging, the CHRG pin is pulled low by an internal N-channel MOSFET. When the charge cycle is completed, When the LC6108 detects an under voltage lockout condition, CHRG is forced high impedance.
11	Ctrl	Sense Feedback Voltage Pin.
12	ISET	Charge Current Program, Monitor the charge current and Shutdown. This pin set to 1V in constant-current mode. The charge current is programmed by connecting a 1% resistor, R <sub>ISET</sub> , to GND pin.

## ELECTRICAL PERFORMANCE

Tested under  $T_A=25^\circ\text{C}$ , unless otherwise specified

**IBAT vs. VBAT**

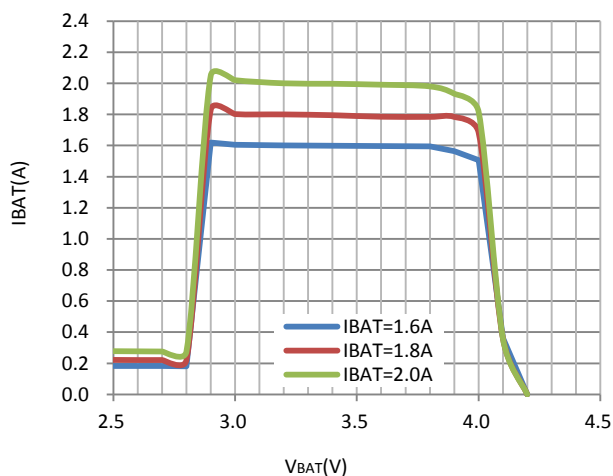

**Efficiency vs. VBAT**

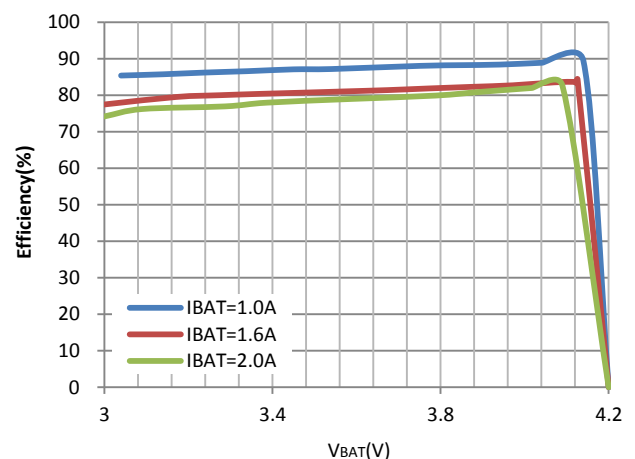

### IBAT vs. Riset

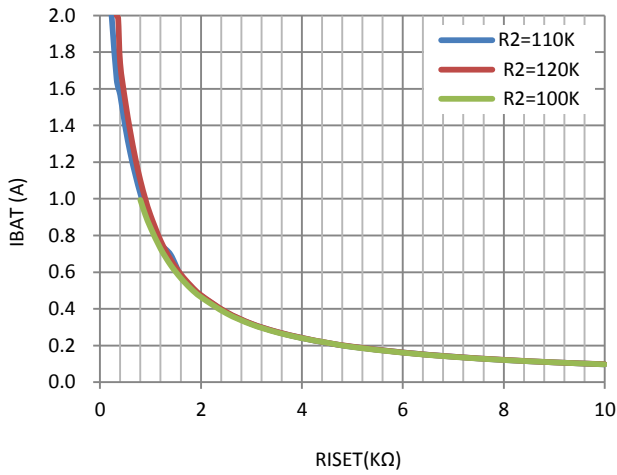

### ISET Pin Pull-up Current vs. Temperature and VIN

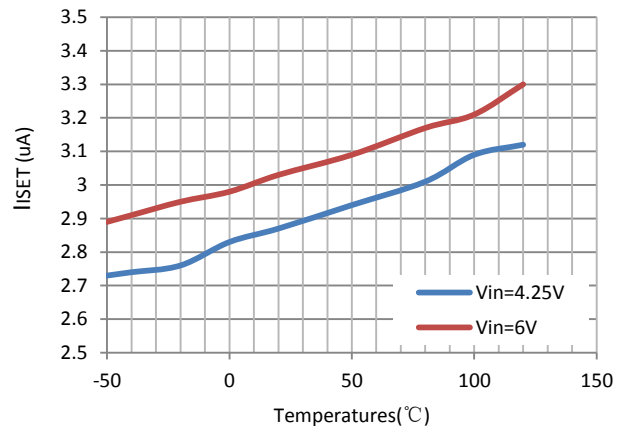

### Regulated Output (Float) Voltage vs. Temperature

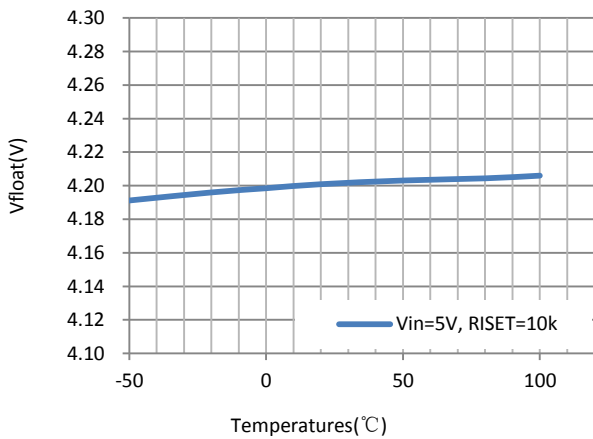

### CHRG pin Current vs. Temperature (strong Pull-down State)

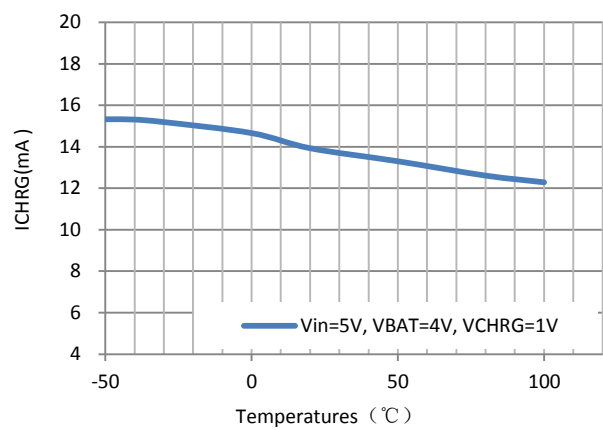

### CHRG Current vs. Temperature

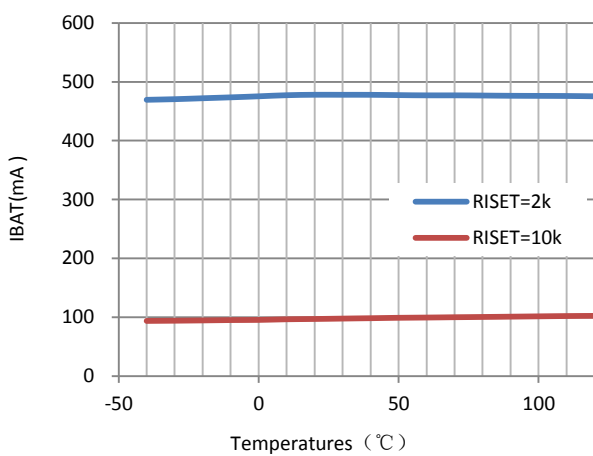

### VISET vs. Temperature

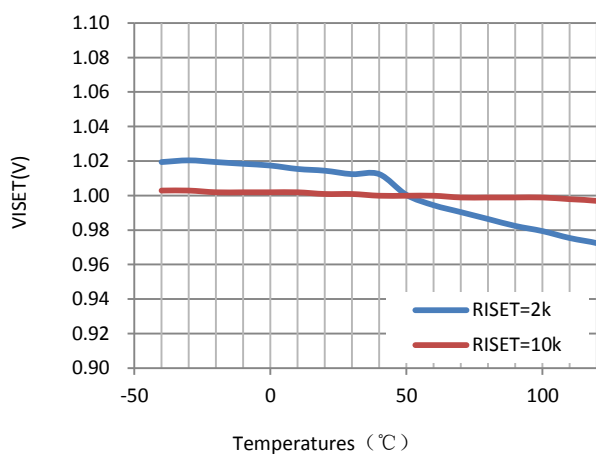

## DETAILED DESCRIPTION

### General description

The LC6108 is a constant current, constant voltage Li-Ion battery switching charger controller. The charge current is set by an external sense resistor ( $R_{ISET}$ ) across the ISET and GND pins. The final battery float voltage is internally set to 4.2V/4.35V per cell. For batteries like lithium-ion that require accurate final float voltage, the internal reference, voltage amplifier and the resistor divider provide regulation with  $\pm 1.5\%$  accuracy.

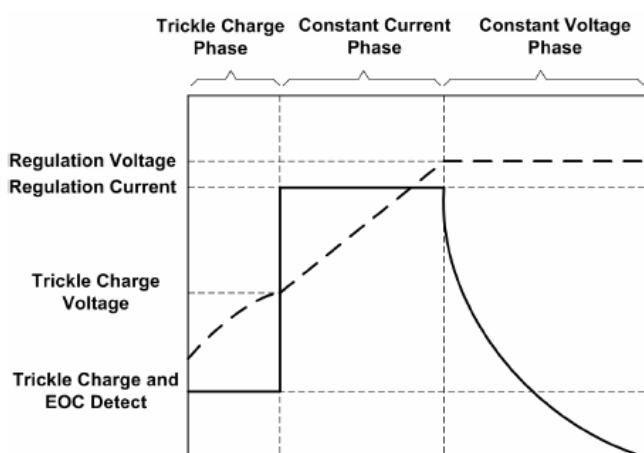

A charge cycle begins when the voltage at the CHRIN pin rises above the UVLO level and is 250mV or greater than the battery voltage. At the beginning of the charge cycle, if the battery voltage is less than the trickle charge threshold, 2.9V for the 4.2 version, the charger goes into trickle charge mode. The trickle charge current is internally set to 10% of the full-scale current. The charge current is programmable by setting the value of a precision resistor connected from the ISET pin to ground. The charge current is 1000 times of the current out of the ISET pin. The program resistor and the charge current are calculated using the following equations:

$$R_{ISET} \approx \frac{1000V}{I_{BAT}}$$

The charge current out of the BAT pin can be determined at any time by monitoring the ISET pin voltage using the following equation:

$$I_{BAT} \approx \frac{V_{ISET}}{R_{ISET}} \cdot 1000$$

When the battery voltage approaches the programmed float voltage, the charge current will start to decrease. It terminates the charge cycle when the charge current falls to 10% of the full-scale value after the final float voltage is reached. When the ISET pin voltage falls below 100mV for longer than  $t_{TERM}$  (typically 1ms), charging is terminated. The charge current is latched off and the LC6108 enters standby mode, where the input supply current drops to 200 $\mu$ A. (Note: C/10 termination is disabled in trickle charging and thermal limiting modes).

### Manual Shutdown

Floating the ISET pin by removing the resistor from ISET pin to ground can put the device in shutdown mode. The battery drain current is thus reduced to less than 5 $\mu$ A and the supply current to less than 50 $\mu$ A. Reconnecting the resistor back will restart a new charge cycle.

Once manually shutdown, the CHRG pin is in a weak pull-down state if  $V_{IN}$  is above UVLO voltage. The CHRG pin is in a high impedance state if the LC6108 is in under voltage lockout mode.

### Automatic Recharge

After the termination of the charge cycle, the LC6108 constantly monitors the BAT pin voltage and starts a new charge cycle when the battery voltage falls below 4.05V, keeping the battery at fully charged condition. CHRG output enters a strong pull-down state during recharge cycles.

### Inductor Selection

The peak-to-peak ripple is limited to 30% of the maximum output current. This places the peak current far enough from the minimum over current trip level to ensure reliable operation while providing enough current ripples for the current mode converter to operate stably. In this case, for 1.6A maximum output current, the maximum inductor ripple current is 667 mA. The inductor size is estimated as following equation:

$$I_{IDEAL} = \frac{(V_{IN(MAX)} - V_{BAT}) \cdot D_{MIN}}{I_{RIPPLE} \cdot F_{OSC}}$$

## Layout Considerations

$C_{IN}$  must be close to Pins VIN and GND, the loop area formed by  $C_{IN}$  and GND must be minimized. Place  $C_{CHRIN}$  as close to Pins CHRIN and GND. The PCB copper area associated with SW pin must be minimized to avoid the potential noise problem. FB Resistors and the traces connecting to the FB pin must not adjacent to the SW net on the PCB

layout to avoid the noise problem. ISET resistor must be as far away with the SW net as possible. The thermal pad under the IC must be tied to the ground area on the top layer, and use via to connect this ground area to any internal ground planes.

## PACKAGE OUTLINE

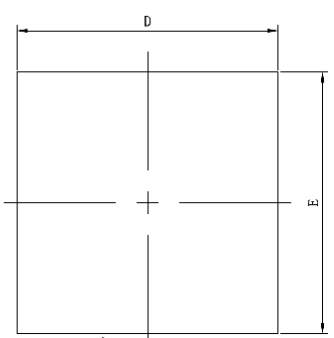
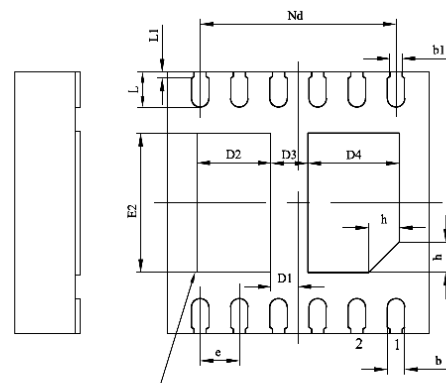
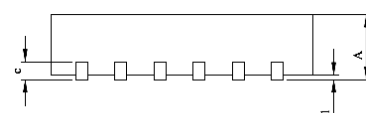
Package	DFN3x3-12L	Devices per reel	3000	Unit	mm																																																																											
Package specification:																																																																																
				<table border="1"> <thead> <tr> <th rowspan="2">SYMBOL</th> <th colspan="3">MILLIMETER</th> </tr> <tr> <th>MIN</th> <th>NOM</th> <th>MAX</th> </tr> </thead> <tbody> <tr> <td>A</td> <td>0.70</td> <td>0.75</td> <td>0.80</td> </tr> <tr> <td>A1</td> <td>—</td> <td>0.02</td> <td>0.05</td> </tr> <tr> <td>b</td> <td>0.15</td> <td>0.20</td> <td>0.25</td> </tr> <tr> <td>b1</td> <td colspan="3">0.14REF</td> </tr> <tr> <td>c</td> <td>0.18</td> <td>0.20</td> <td>0.25</td> </tr> <tr> <td>D</td> <td>2.90</td> <td>3.00</td> <td>3.10</td> </tr> <tr> <td>D1</td> <td>0.26</td> <td>0.31</td> <td>0.36</td> </tr> <tr> <td>D2</td> <td>0.75</td> <td>0.85</td> <td>0.95</td> </tr> <tr> <td>D3</td> <td>0.32</td> <td>0.42</td> <td>0.52</td> </tr> <tr> <td>D4</td> <td>0.95</td> <td>1.05</td> <td>1.15</td> </tr> <tr> <td>e</td> <td colspan="3">0.45BSC</td> </tr> <tr> <td>Na</td> <td colspan="3">2.25BSC</td> </tr> <tr> <td>E</td> <td>2.90</td> <td>3.00</td> <td>3.10</td> </tr> <tr> <td>E2</td> <td>1.50</td> <td>1.60</td> <td>1.70</td> </tr> <tr> <td>L</td> <td>0.30</td> <td>0.40</td> <td>0.50</td> </tr> <tr> <td>L1</td> <td colspan="3">0.10REF</td> </tr> <tr> <td>h</td> <td>0.30</td> <td>0.35</td> <td>0.40</td> </tr> </tbody> </table>		SYMBOL	MILLIMETER			MIN	NOM	MAX	A	0.70	0.75	0.80	A1	—	0.02	0.05	b	0.15	0.20	0.25	b1	0.14REF			c	0.18	0.20	0.25	D	2.90	3.00	3.10	D1	0.26	0.31	0.36	D2	0.75	0.85	0.95	D3	0.32	0.42	0.52	D4	0.95	1.05	1.15	e	0.45BSC			Na	2.25BSC			E	2.90	3.00	3.10	E2	1.50	1.60	1.70	L	0.30	0.40	0.50	L1	0.10REF			h	0.30	0.35	0.40
SYMBOL	MILLIMETER																																																																															
	MIN	NOM	MAX																																																																													
A	0.70	0.75	0.80																																																																													
A1	—	0.02	0.05																																																																													
b	0.15	0.20	0.25																																																																													
b1	0.14REF																																																																															
c	0.18	0.20	0.25																																																																													
D	2.90	3.00	3.10																																																																													
D1	0.26	0.31	0.36																																																																													
D2	0.75	0.85	0.95																																																																													
D3	0.32	0.42	0.52																																																																													
D4	0.95	1.05	1.15																																																																													
e	0.45BSC																																																																															
Na	2.25BSC																																																																															
E	2.90	3.00	3.10																																																																													
E2	1.50	1.60	1.70																																																																													
L	0.30	0.40	0.50																																																																													
L1	0.10REF																																																																															
h	0.30	0.35	0.40																																																																													
		<p>EXPOSED THERMAL PAD ZONE</p> <p>BOTTOM VIEW</p>																																																																														

 代理商：深圳市琪远电子有限公司  
 电话：(0755)86228541 / 17727576605  
 更多产品请访问：www.siiitek.com.cn